

INSTRUCTION MANUAL

FL2100B

YAESU MUSEN CO., LTD.

TOKYO, JAPAN

FL-2100B LINEAR AMPLIFIER

GENERAL

The FL-2100B Linear Amplifier is designed to match the FT-101B/277B transceivers in appearance and drive requirements to run high power input covering the ham bands 80 through 10 meters.

The FL-2100B uses a pair of 572B/T160 transmitting triodes in a class B grounded grid circuit configuration. The tubes are forced-air cooled by two very quiet high speed internal fans.

Automatic Level Control circuit controls the exciter gain to allow the highest average power without distortion caused by peak clipping. Change-over circuit biases the tubes to cut-off, eliminating unwanted heat and diode noise generation when receiving.

An internal changeover relay feeds the antenna to the exciter for barefoot operation when the FL-2100B is turned off or is on standby condition. A built-in SWR bridge measures SWR on by barefoot and linear operations.

The built-in solid state power supply requires no warm-up period and provides excellent voltage regulation.

CAUTION

DO NOT TURN ON THE FL-2100B WITH THE TOP SHIELD COVER REMOVED. THE HIGH VOLTAGE SAFETY LOCK SHORTS OUT THE HIGH VOLTAGE AND WILL DAMAGE THE POWER SUPPLY CIRCUIT.

Circuit	: Grounded Grid Class B
Frequency Coverage	: Ham bands 80 through 10 meters
Plate Input	: 1200 Watts PEP, 1000 Watts CW and 600 Watts AM
Plate voltage	: 2400 Volts DC
Drive Requirement	: 100 Watts PEP
Input Impedance	: 50 ohms, unbalanced
Output Impedance	: 50 - 75 ohms, unbalanced
Third Order Distortion	: 30 db or better at 1000 Watts PEP
Tube Complement	: 2 × 572B/T160
Cooling	: Forced-air cooling
Power Requirements	: AC 100, 110, 117 Volts 50/60Hz 18 Amps AC 200, 220, 234 Volts 50/60Hz 9 Amps
Dimensions	: 13 $\frac{1}{2}$ " Wide, 6" High, 11 $\frac{1}{2}$ " Deep
Weight	: 41 lbs

FRONT PANEL CONTROLS

POWER-OFF	: Rocker switch turns power on.
OPER-STBY	: Rocker switch applies Bias when standby and relay is disengaged.
SWR-IP	: Rocker switch selects either SWR or plate current meter reading.
F-R	: Rocker switch selects either forward or reflected SWR bridge reading.
SENS	: Potentiometer adjusts meter sensitivity for SWR measurement.
PLATE	: Plate capacitor in tank circuit.

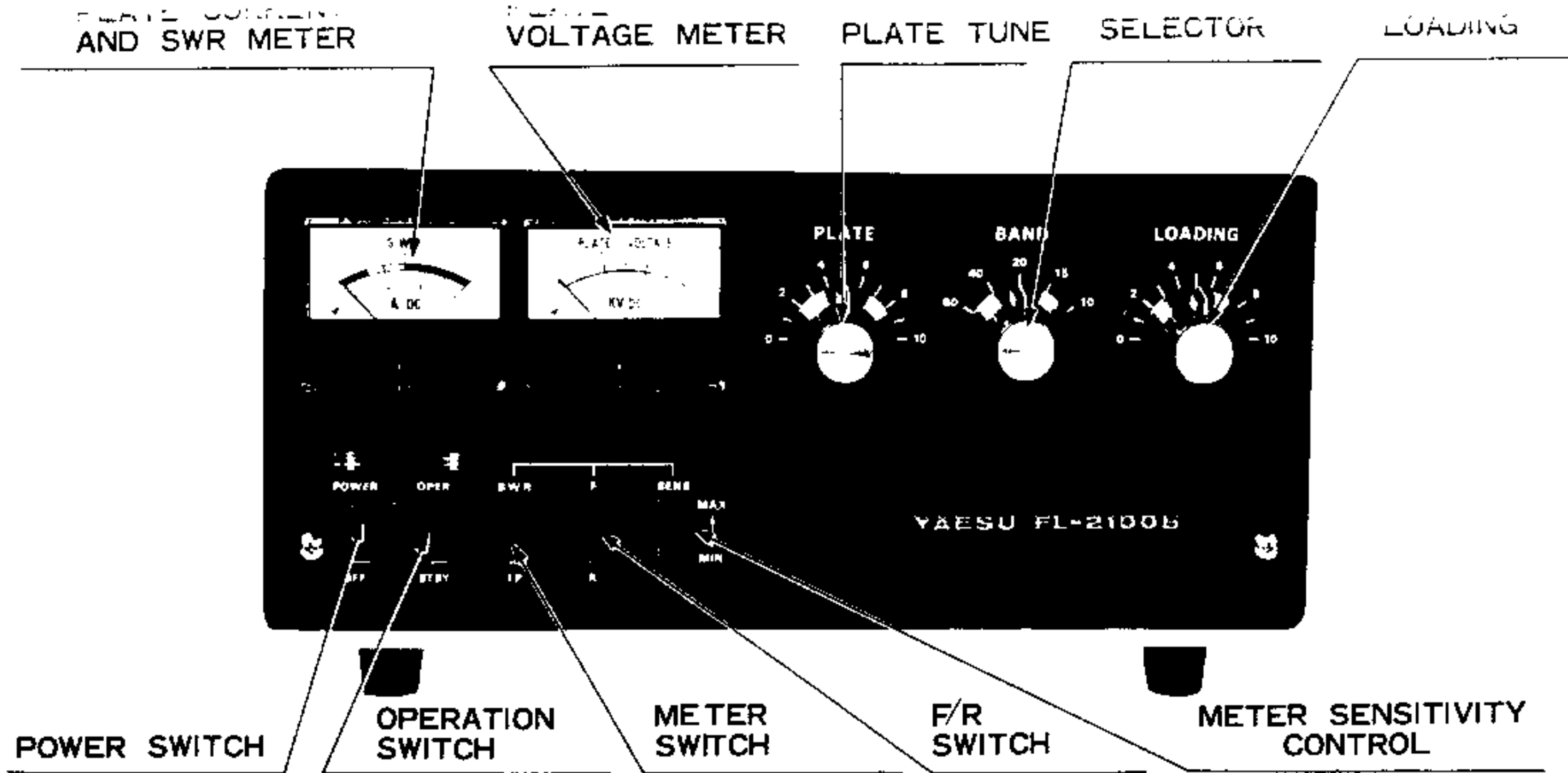

FRONT VIEW

INSTALLATION

The FL-2100B has been designed incorporating a safety lock to prevent dangerous high voltage shock. However, extreme care is recommended when servicing inside the cabinet.

Unpacking

Carefully remove FL-2100B from the packing carton and examine them for any visible shipping damage, check the control knobs and switches for complete freedom of action.

In general, care should be taken to insure that enough space is allowed around the amplifier cabinet to permit adequate air circulation within the linear amplifier. Do not cover the top of the FL-2100B with books, papers or other equipment. Do not insert anything under the bottom of the FL-2100B or overheating may result.

POWER REQUIREMENT

The FL-2100B has a built-in power supply which can be operated from either 100, 117 or 220 volts AC 50-60 Hz.

Be sure that the voltage marked on the rear of the FL-2100B agrees with the local AC supply voltage.

CAUTION

PERMANENT DAMAGE WILL RESULT IF IMPROPER AC SUPPLY VOLTAGE IS APPLIED TO THE FL-2100B

It is recommended that the FL-2100B is operated from its own 220 volt 10 amp or greater circuit. If 117 or 100 volts is all that is available, it should be fused for 20 Amps, circuit conductors should be larger than # 10 and no other equipment should be operated from this circuit. DO NOT, under any circumstances, operate the FL-2100B from a 117 volt lighting circuit, as the circuit conductors are not large enough to carry this load.

The following diagram shows the wiring connections for 117 and 220 volt operation. Connections must be made as shown or serious damage may result.

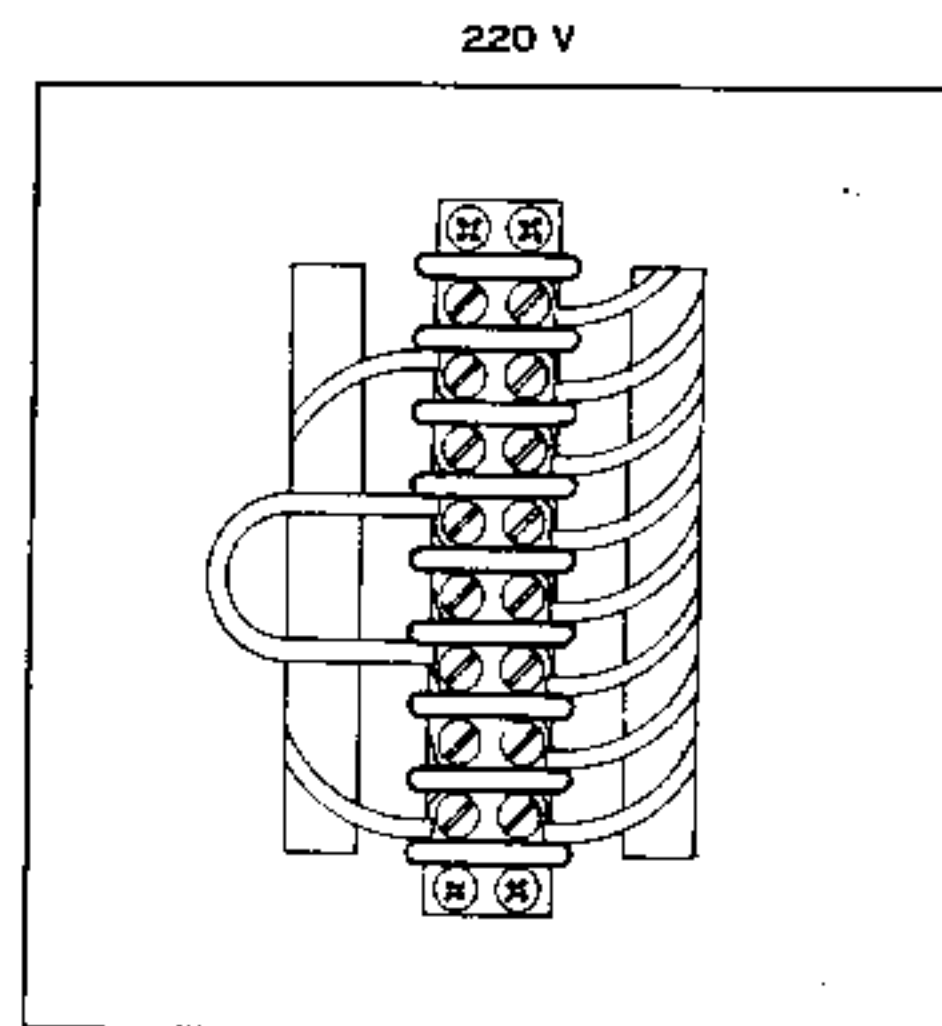
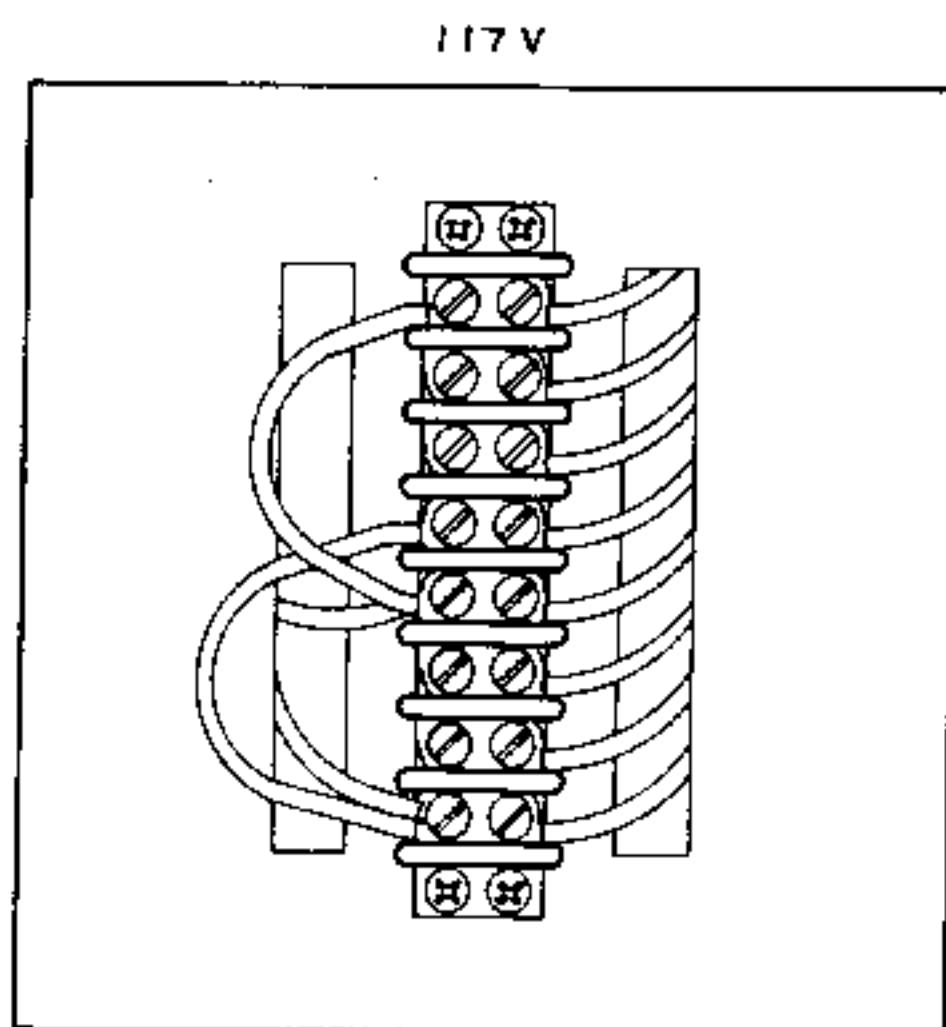

ANTENNA REQUIREMENT

The FL-2100B has been designed for use with an antenna resonant at the operating frequency and having approximate impedance within the limit of 40 to 80 ohms. The nominal output impedance of the FL-2100B is 50 ohms. When the impedance of the antenna used is far from this value, it is recommended that an antenna matching network be used which will allow the FL-2100B to work into its nominal 50 ohm load for maximum power transfer into the antenna.

GROUND REQUIREMENT

The FL-2100B should be connected to a good earth ground through as short and as large a gauge wire as possible for best performance and maximum safety. A connecting post marked "GND" is provided on the rear apron of the chassis.

CAUTION

NEVER OPERATE THE FL-2100B WITHOUT CONNECTING IT TO AN EARTHGROUND, AND AN ANTENNA OR 50 OHM DUMMY LOAD, OR SERIOUS DAMAGE MAY RESULT.

EXCITER REQUIREMENT

To operate the FL-2100B at its maximum power input, it will be required that the exciter deliver 100 Watts PEP SSB output.

The exciter should be placed as close to the amplifier as practical to avoid long coax and ground connections.

ALC

On the rear of the FL-2100B, a terminal is provided for connection to the exciter of the ALC voltage which controls the gain of the exciter to prevent distortion caused by peak clipping.

Relay Control

RY and E terminal on the rear of the FL-2100B are provided for connection to the exciter relay circuit which is normally open, and which closes on transmit and thus keys the FL-2100B at the same time. E terminal should be connected to ground for exciters whose relay contact connects to ground on transmit. The terminals are jumpered with a wire for testing purposes when the unit is shipped from the factory.

OPERATION

CAUTION

BE SURE THAT THE FL-2100B IS CONNECTED TO A 50 OHM ANTENNA SYSTEM OR A 50 OHM DUMMY LOAD AND THAT THE PROPER POWER CONNECTION HAS BEEN MADE FOR THE LINE VOLTAGE THAT IS TO BE USED. (SEE PAGE 4)

For all modes of operation, the FL-2100B is tuned up with a single R.F. frequency driving it. The exciter may be tuned up on CW into the antenna connected to the FL-2100B with operation switch at STBY position, or by leaving the FL-2100B power off. After the exciter has been tuned up, turn the exciter to standby and turn the operation switch to "OPER" position.

Presetting of the Controls

POWER switch	: OFF
OPER switch	: STBY
SWR/IP switch	: IP
BAND switch	: Desired band
PLATE Control	: To the number given in the following chart
LOAD Control	: Fully counter-clockwise on number zero

BAND	PLATE	LOADING
80	1—6.5	1.5—5.5
40	6—7	3
20	7—8	3.5
15	9—9.5	4
10	9—10	4.5

Turn the power switch of FL-2100B on and wait for a few seconds for tube warm up. Turn OPER switch onto "OPER" position.

Turn on the exciter and increase the exciter output while not exceeding 0.2 Amps plate current and tune the plate control for dip in the plate current. Alternately adjust the plate and loading controls while increasing the exciter power in small increments until maximum R.F. output occurs at 0.5 Amps plate current. Do not exceed 10 seconds at maximum input to protect the tubes.

To measure relative power output, set the meter switch to "SWR" and "F" (forward) position. If the relative output meter goes off scale during tune up, reduce the meter sensitivity control in a downward direction. Approximate settings of the loading control at maximum input are given in the chart above for 50 ohm load.

Now you are ready for CW and SSB operation.

For SSB operation, the exciter should be adjusted to run the FL-2100B plate current between 0.2 and 0.3 Amps under normal voice operating conditions, because the meter cannot follow speech speed.

For AM operation, tune up the FL-2100B as described previously. Then the exciter should be adjusted to run the FL-2100B at 0.2 Amps plate current with unmodulated carrier.

To measure the SWR of the antenna system, set the meter switch to SWR and apply R.F. power to the antenna. Adjust the meter sensitivity control to read

full scale at SWR switch "F" position. Turn SWR switch to "R" position, then SWR may be read directly from upper scale of the meter.

THEORY OF OPERATION

The FL-2100B is designed to use two 572B/T160 zero bias triodes in a class B grounded grid configuration.

The RF driving power delivered to the input is applied to the tube filaments through a changeover relay and a pi-network on each band which is selected by the input switch S2b. The input switch is ganged to the band switch S1.

The RF voltage appearing on the grid of the tube is coupled through C203 to ALC rectifier diodes D201 and D202. The plate potential of D201 is determined by R1, R2, R3, so that adequate automatic level control voltage is available to control the exciter. The bias is set by R4 for 0.09 Amps idle current. In standby, the cold end of S4 is opened so that bias voltage cuts off the tubes. The plate circuit is coupled to the 50 ohm output load by an adjustable pi-network through the SWR bridge circuit.

SERVICING

WARNING

EXTREME CAUTION SHOULD BE TAKEN WHENEVER MAKING ANY ADJUSTMENTS INSIDE THE CABINET. BEFORE REMOVING THE CABINET UNPLUG THE POWER PLUG FROM THE AC LINE.

Removing the Bottom Cover and the Cabinet

After disconnecting the power cord from the AC line, the bottom cover can be removed by taking out the four screws on it.

After removing four screws on the front end and four on the bottom of the cabinet, the cabinet can be slid out backwards from the chassis and panel assembly.

Removing Shield Cover

After removing the cabinet, the shield cover of the PA compartment can be removed by taking out two screws on the shield cover. The safety lock shorts out the charge condensed in the capacitor.

Tube Replacement

If it becomes necessary to replace the tubes in the FL-2100B, the same manufacturer brand should be used.

Trouble Shooting

During long periods of operation, it is quite possible that some problem will arise which cannot be cured by tube substitution. If this occurs, it is recommended that you either return it to your dealer or write us in detail.

Input Coil Alignment

The input coils are adjusted at the factory for the center of each band and are broad enough to cover the entire band. However, if the tubes are replaced with a brand other than originally supplied, the input coils may have to be realigned. The alignment is done with a 50 ohm SWR meter inserted between the exciter output and the FL-2100B's RF input coax jack. First disconnect the FL-2100B from the power line, remove the bottom cover and the cabinet disconnect the wiring from the high voltage terminals of the transformer.

The amplifier should be connected to the exciter as for normal operation with the exception of the SWR meter in the input line. Preset the controls as follows:

Band Switch	:	On desired band to be tuned
Loading	:	Fully counter-clockwise
Plate Control	:	In the position described on page 7

With the exciter tuned up on CW in the middle of the band to be tuned, turn on the FL-2100B. The amplifier now works without plate voltage. Extreme care should be taken, because there is high voltage AC on the secondary terminals of the power transformer.

Increase the output from the exciter until the amplifier plate meter read 0.1 Amps. Tune the plate control for a dip in plate current and tune the slug on the correct input coil for a minimum reflected power reading on the SWR meter that is connected to the input line.

After re-alignment, disconnect the power cord from the AC line and reconnect the disconnect wiring to the secondary terminals of the transformer.

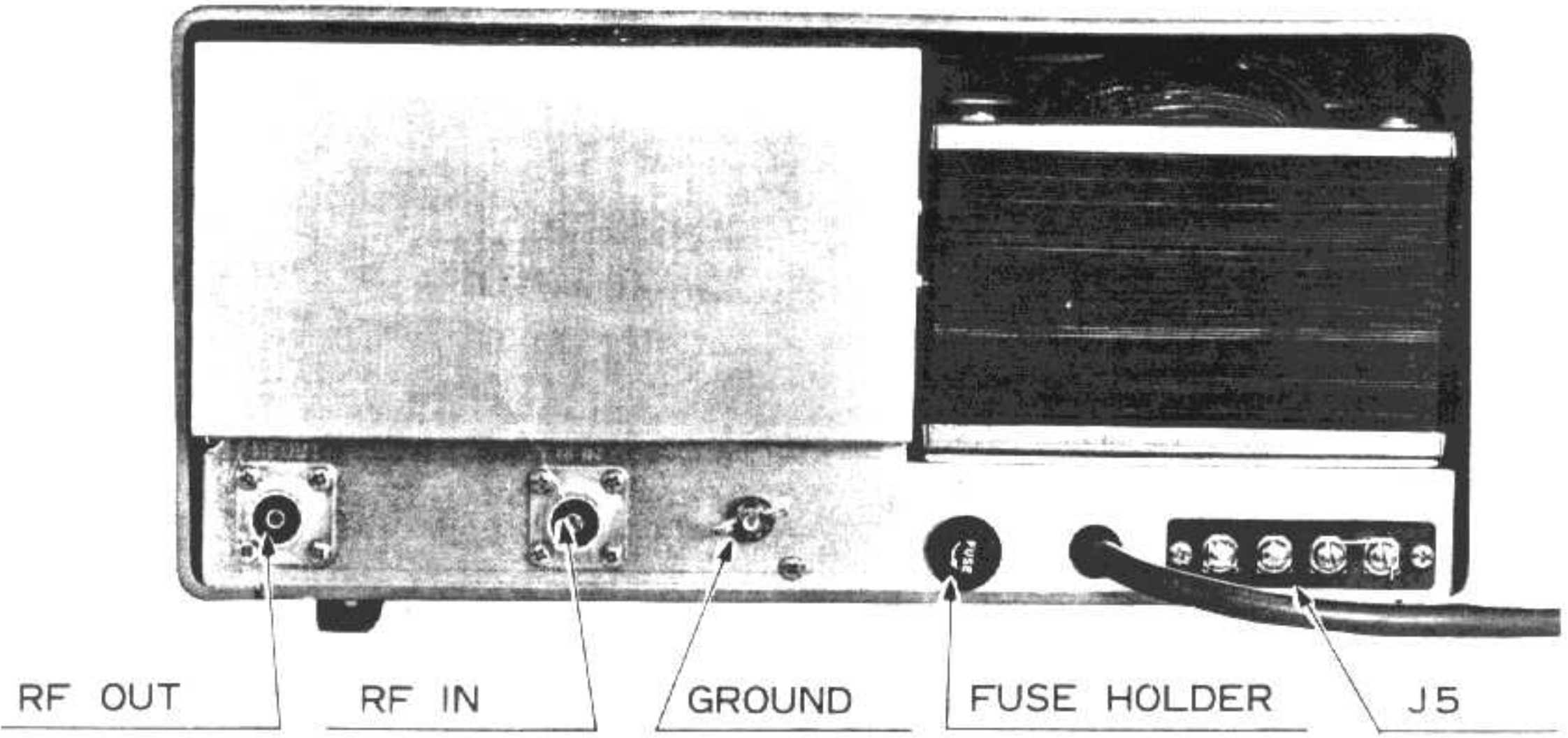

REAR VIEW

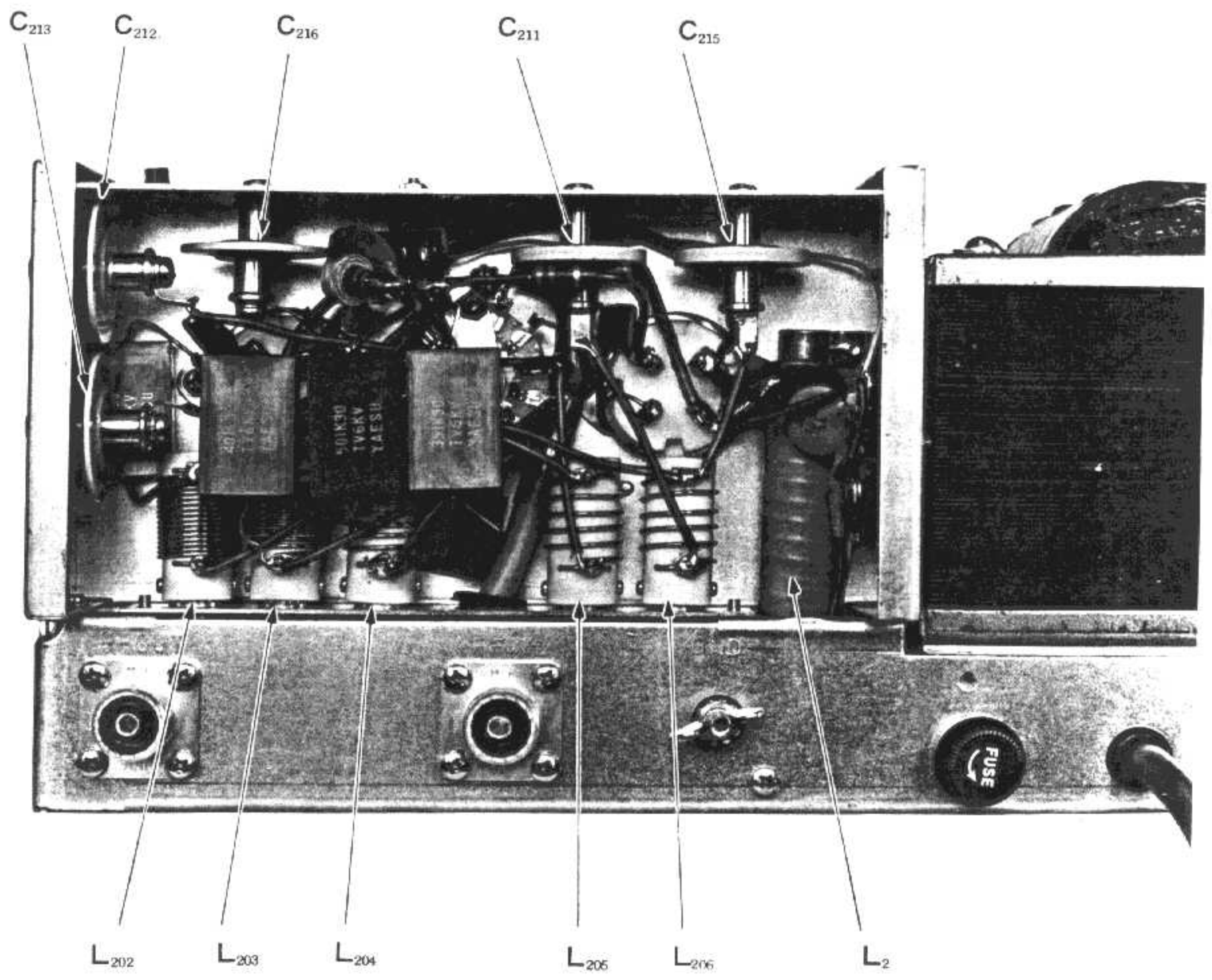

INPUT TUNING CIRCUIT

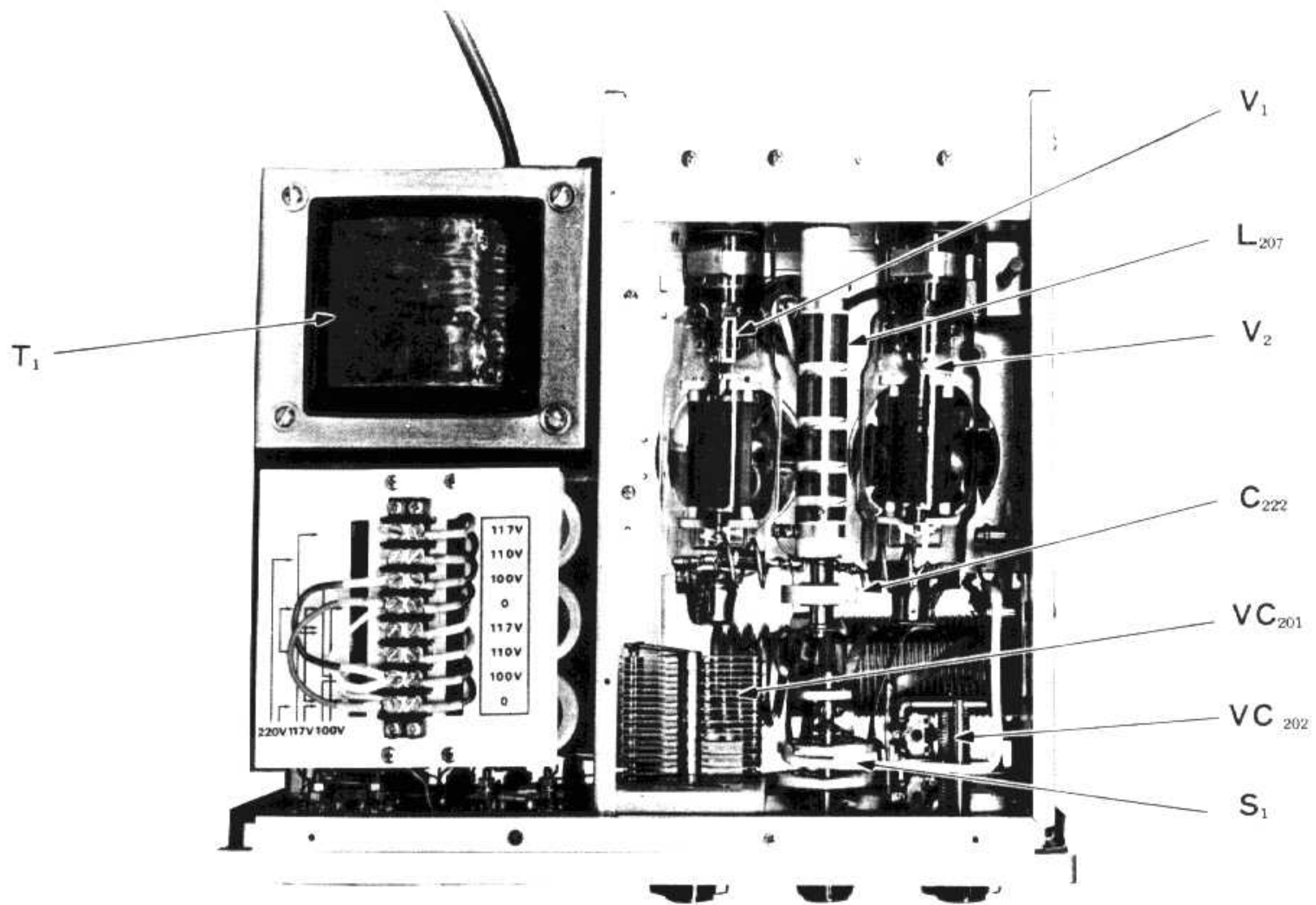

TOP VIEW

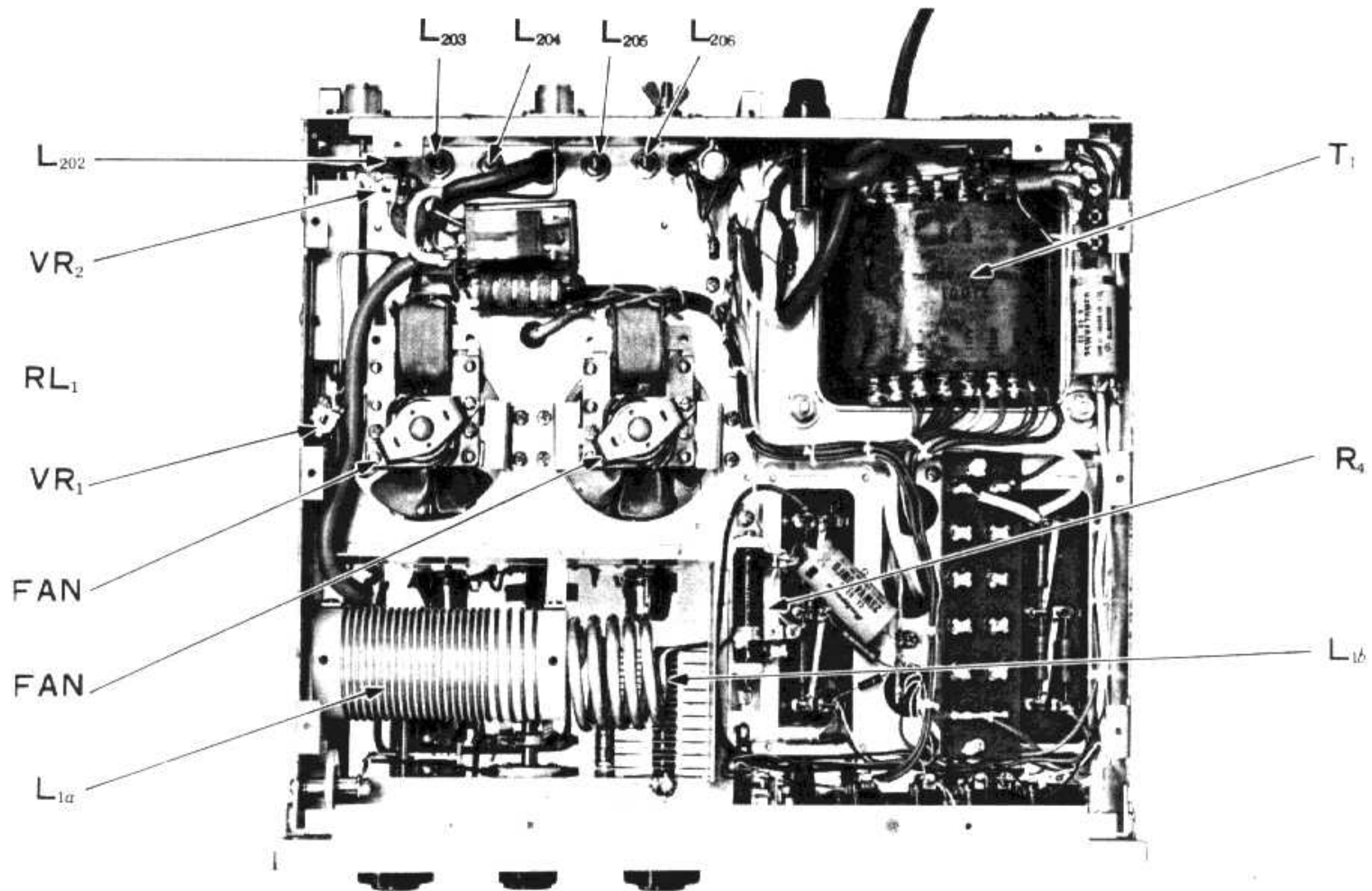

BOTTOM VIEW

INTERCONNECTION DIAGRAM

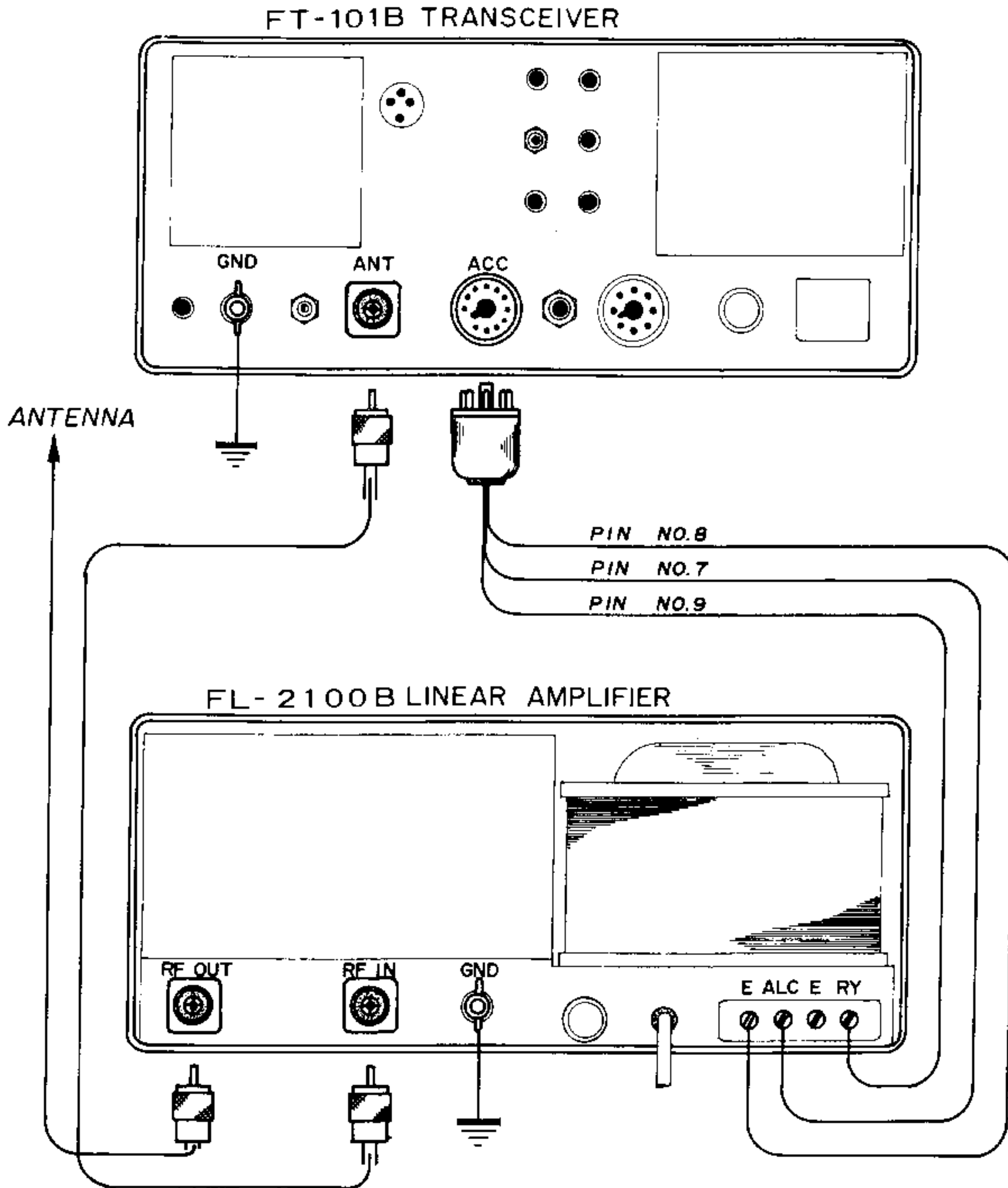

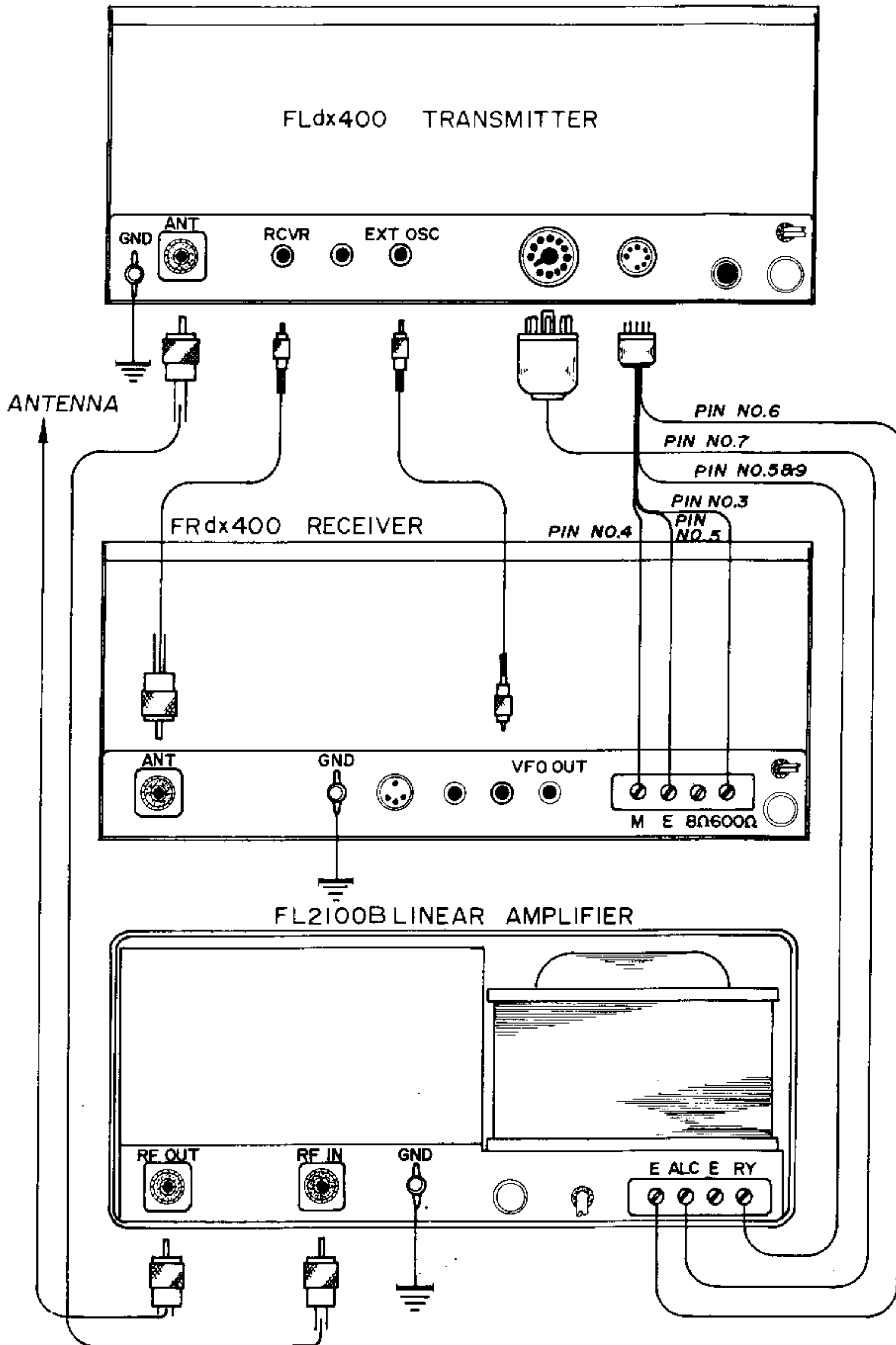

1, 2	1.4KV DC	0.01 μ F		2	2 4 5
3, 4, 7, 8, 9	CERAMIC DISC	500WV	0.01 μ F	3	(POWER) WD 2301
205 - 208, 210, 225			$\pm 100\%$	4	(OPER. STBY) WD 2301
5	ELECTROLYTIC	25WV	1000 μ F	5	(METER SW) WD 2101
209	ELECTROLYTIC	50WV	2.2 μ F	6	(SWR F R) WD 2101
101 - 106	ELECTROLYTIC	500WV	100 μ F	7	P SAFETY LOCK
201, 202	DIPPED MICA	500WV	200PF $\pm 10\%$		F-FUSE
203	"	"	5PF "	1	AC 100V - 117V 20A
204	"	"	50PF "		AC 200V - 234V 15A
215, 224	CERAMIC	TV3K RDA-30	100PF		FH-FUSE HOLDER
212, 217	"	"	250PF	1	SN-1001
211, 216	"	"	200PF		PL-PILOT LAMP
226	"	"	300PF	1, 2	14V 30mA
221, 222	"	"	1000PF		M-METER
223	CERAMIC	TV3K RDA 40	500PF	1	PF-45-1675 1mA/600mA
213	MICA	TV6K	350PF	2	PF-45-1674 3KV
214	"	"	500PF		FAN
219, 220	"	"	1000PF	1, 2	2S10A (FAN)
218	"	"	400PF		J-JACK
	R-RESISTOR			2	H, 8P
101 - 110	$\frac{1}{2}$ W	470K Ω	$\pm 10\%$	3, 4	JSO 239 (INCH)
2	"	2.2K Ω	"	5	4PC
204	"	4.7K Ω	"		P-PLUG
201, 202	1 W	33 Ω	$\pm 10\%$	3, 4	JPL 259 (INCH)
203	"	3.3K Ω	"		VC-VARIABLE CAPACITOR
5	2 W	1.5M Ω	$\pm 10\%$	201	(PLATE VC) 115PF (MAX) AIR
205, 206	"	22 Ω	"	202	(LOADING VC) 430PF \times 2 AIR
207	"	47K Ω	"		VR-VARIABLE RESISTOR
1, 111 - 115	"	220K Ω	"	1, 2	B500 Ω
4	VARIABLE (BIAS SET)	10W	30 Ω	3	B100K Ω
3	M-1	SHUNT			L-INDUCTOR
1, 2	V-VACUUM TUBE	572B/T 160L		1a	TANK COIL
1, 2	VS-VACUUM TUBE SOCKET	UX	4P	1b	10 M TANK
2, 3, 201	D-DIODE	IS 1007		201	GRID RFC
1, 202	SILICON	1S1943 or	SH-1	202	80 M INPUT COIL
101 - 110	"	10D10		203	40 M "
	T TRANSFORMER			204	20 M "
1	POWER			205	15 M "
				206	10 M "
				207	PLATE RFC
				2	HEATER CHOKE
				3	RFC
				208, 209	PARASTIC COIL
					RI-RELAY
				1	AW 5221 GK DC 12V

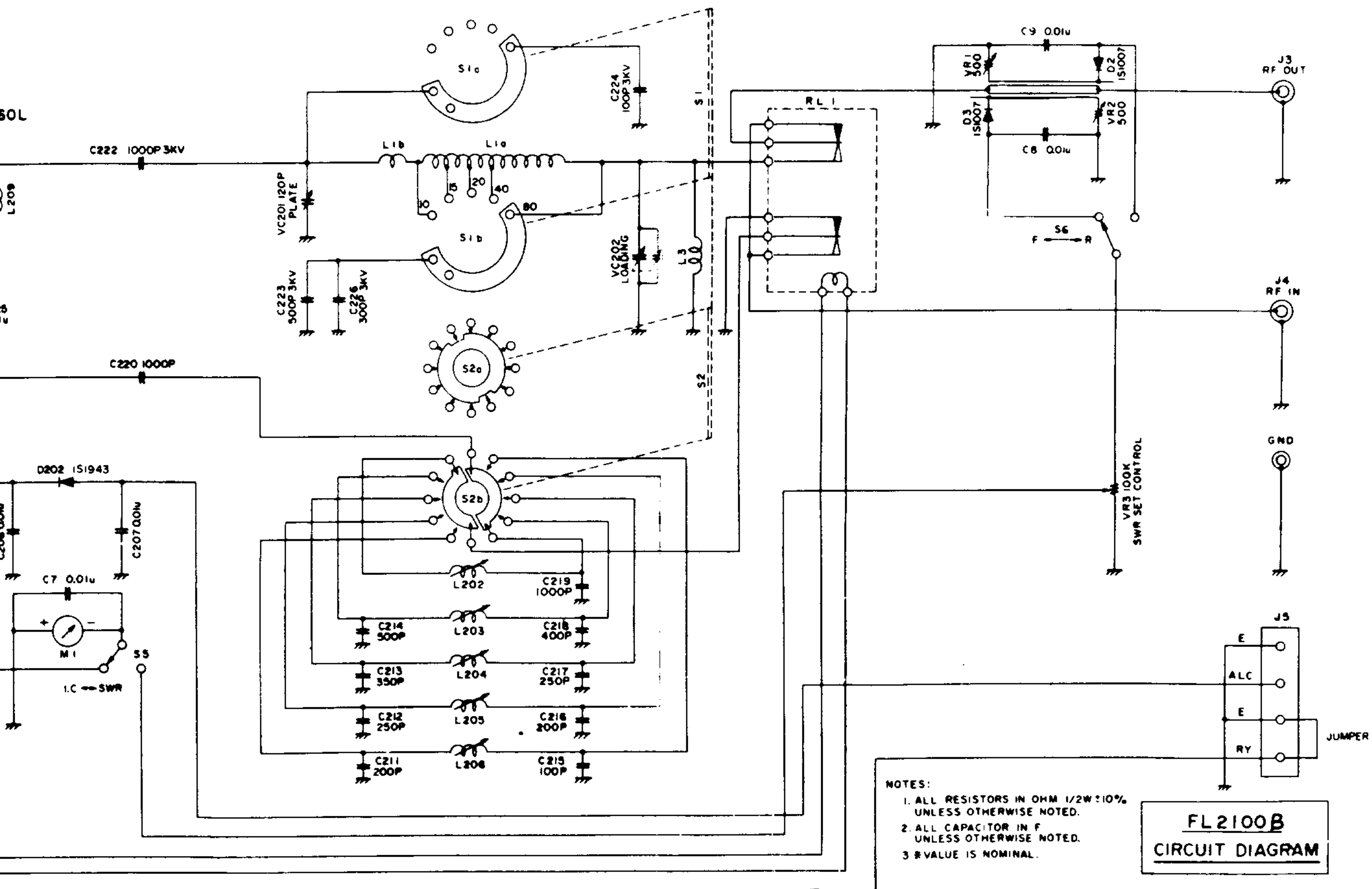

- NOTES:
1. ALL RESISTORS IN OHM 1/2W:10% UNLESS OTHERWISE NOTED.
 2. ALL CAPACITOR IN F UNLESS OTHERWISE NOTED.
 3. R VALUE IS NOMINAL.

FL2100B
CIRCUIT DIAGRAM